

SCREW AIR COMPRESSOR CONTROLLER

MODLE: MAM-880

USER

MANUAL

Shenzhen Plot Electronic Co., Ltd

Address: 4-5F,5 Bldg,Highstar Industry Park,Gangtou Community,
Bantian,Longgang District,Shenzhen City, China

Telephone: (+86 0755) 83173599 / 83172822 Postal code: 518129

Fax: (+86 0755) 83172966

E-mail: plt@pltsz.com

Web site: www.pltsz.com

VOTE OF THANKS

Thank you for your trustworthy and select of PLOT air compressor controller !

Shenzhen Plot Electronic Co., Ltd specializes on the manufacture and R&D of air compressor controller. We are devoted to win customer trust through our high quality products and service.

We try our best to ensure the completeness and correctness of the manual, but PLOT Company shall reserve the rights for continuous research and improvement on its products and assume no obligation for the modification and improvement on the previously delivered products. The design of products is subject to the change without notice.

Please feel free to contact our after-sale service center if you encounter any problem with our product.

You are always welcome to make suggestions and advices!

Notice



Please read all the operation manual before operating the set and keep this manual for further reference.



Installation of MAM—8** compressor controller can be performed only by professional technicians.



Installation position shall be considered carefully in order to ensure good ventilation and reduce electromagnetic interference.



Wiring shall be performed respectively according to regulations for heavy and weak current to reduce electromagnetic interference.



RC snubber must be connected to the two terminals of coil (such as AC contactor ,valve, etc),which are controlled by relay output.



Port connection shall be inspected carefully before power on.



Correct ground connection (the third ground)can help increase product capacity of resisting signal interference.



Set rated current of motor: the max current of motor/1.2.

Features:

- Chinese / English display.
- Remote control/Local control.
- Block mode/Independent mode.
- On-off control of motor.
- Prevention for air compressor reversion.
- Temperature measurement , control and protection .
- Voltage measurement and protection.
- RS485 communication function, supporting MODBUS RTU protocol.
- Protection for open phase, overload current, unbalance current, high voltage ,low voltage .
- High integration , high reliability ,high cost performance.

Contents

| | |
|---|--------|
| 1、 Basic Operation | - 3 - |
| 1、 Button explanation..... | - 3 - |
| 2、 Indicator Instruction..... | - 4 - |
| 3、 Status Display and Operation | - 4 - |
| 4、 Operating Parameter and Menu | - 4 - |
| 5、 User Parameter View and Modification:..... | - 5 - |
| 6、 User Parameter Sheet and Function..... | - 6 - |
| 7、 Factory Parameter View and Modification | - 8 - |
| 8、 Factory Parameter Sheet and Function | - 9 - |
| 9、 Parameter Calibration | - 10 - |
| 10、 Operating Authorization and Password | - 11 - |
| 2、 Controller Function and Technical Parameter | - 12 - |
| 3、 Model and Specification | - 13 - |
| 1、 Model Description | - 13 - |
| 2、 Power consumption Table for Corresponding Motor..... | - 13 - |
| 4、 Installation | - 14 - |
| 1、 Mechanical Installation..... | - 14 - |
| 2、 Electrical Wiring Installation | - 16 - |
| 5、 Control Process..... | - 17 - |
| 1、 Single Machine | - 17 - |
| 2、 Net Work..... | - 18 - |
| 3、 Fan Operation | - 18 - |
| 6、 Alarm Function..... | - 18 - |
| 1、 Air Filter Alarm | - 18 - |
| 2、 Oil Filter Alarm | - 18 - |
| 3、 O/A separator Alarm..... | - 18 - |
| 4、 Lubricating Oil Alarm..... | - 18 - |
| 5、 Grease Alarm..... | - 18 - |
| 6、 Belt Alarm..... | - 18 - |
| 7、 High Discharge Air Temperature Alarm | - 18 - |
| 7、 Controller Protection | - 19 - |
| 1、 Motor Protection..... | - 19 - |
| 2、 Protection of Air Temperature High | - 19 - |
| 3、 Protection of Air Compressor Non-reversing | - 19 - |
| 4、 Protection of High Pressure | - 19 - |
| 5、 Protection of Sensor Failure | - 19 - |
| 6、 Low Temperature Protection..... | - 19 - |
| 8、 Troubleshooting..... | - 19 - |
| 1、 This Fault Review | - 19 - |
| 2、 Common Failures and Causes..... | - 20 - |
| 9、 Block mode control and net work..... | - 21 - |
| 10.Schematic Diagram..... | - 24 - |

1、 Basic Operation

1、 Button explanation

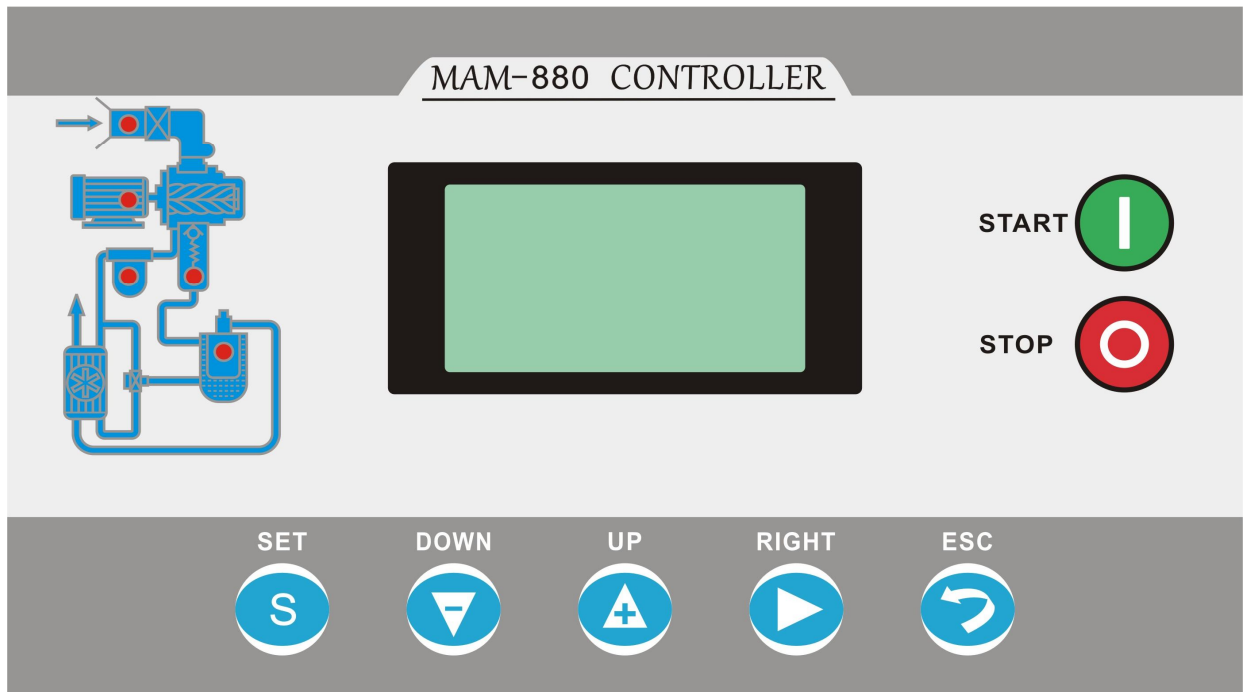

Figure 1.1.1



—Start Button:

- 1, When compressor is at stop status, press this button to start the compressor.
- 2, When compressor is set as master (No.1) in block mode ,press this button to start the compressor and activate block mode function at the same time.



—Stop Button:

- 1, When the compressor is at running status, press this button to stop the compressor;
- 2, When compressor is set as master (No.1) in block mode ,press this button to stop compressor and block mode function as well;
- 3, When compressor is at stop status, long press this button to display software edition.



—Set Button /Loading / unloading Button:

- 1, When the compressor is at running status ,press this button to load, unload ;
- 2, When the compressor is at setting mode, press this button after modification to confirm and save the modified data.



—Move down button / Decreasing button:

- 1, When viewing the menu, press this button to move downward the cursor;
- 2, When modifying data, press this button to decrease the data at current position.



—Move up button/Increasing button:

- 1, When viewing the menu, press this button to move upward the cursor ;
- 2, When modifying data, press this button to increase the data at current position .



—Shift button /Enter button:

- 1, When modifying data, press this button to move to the next data bit;
- 2, When select menu, press this button to switch to submenu. If no submenu available, the controller will shift to data setting mode.



—Return button / Reset button:

- 1, When modifying data, press this button to exist data setting mode;
- 2, When viewing the menu, press this button to return to previous menu;
- 3, When the controller is at failure stop status, long press this button to reset.

2、Indicator Instruction

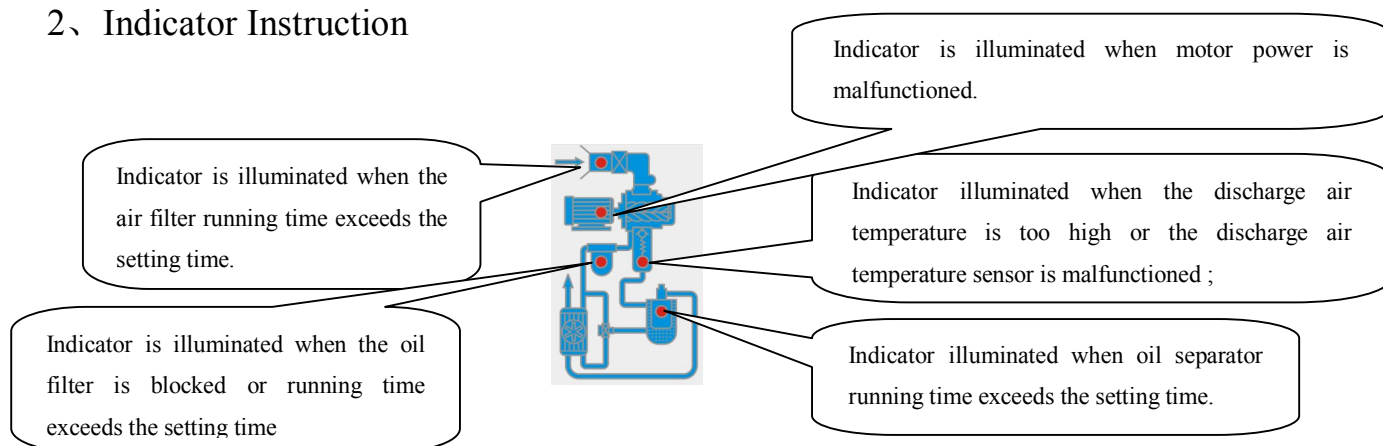

3、Status Display and Operation

The display screen will show as below after power on:

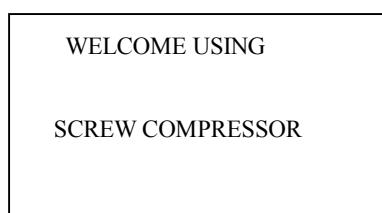

← After power on, show this menu

After 5 seconds, the menu will switch as below:

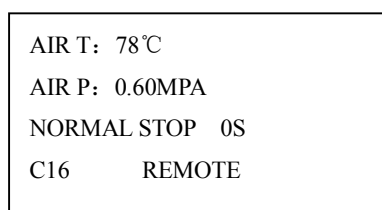

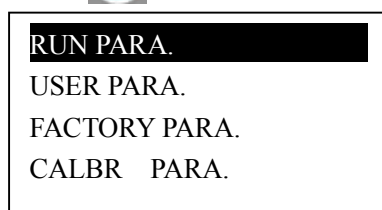

← Main menu

Press “” to enter into Selection Menu:





← Level 1 menu

4、Operating Parameter and Menu

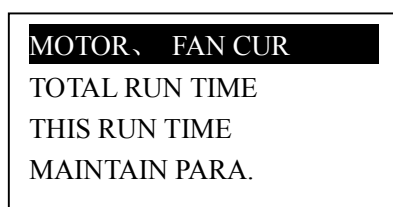
Press “” or “” to move the cursor to “RUN PARAMETER”, then press “” to switch to secondary menu:





| |
|----------------------|
| HISTORY FAULT |
| PRODUCTION DATE、NUM. |
| THIS FAULT |
| COM STATUS |

Move the cursor to the corresponding menu item, press “” to check the specific parameter. Such as viewing "MOTER FAN CUR ", move the cursor to the " MOTER FAN CUR " menu item, press the “”, switch to the item of motor , fan data .

| | |
|----------|---------|
| MAIN (A) | FAN (A) |
| A 50.1 | 2.1 |
| B 50.1 | 2.1 |
| C 50.1 | 2.1 |

Press the “” to return to the previous menu or the main menu. If no operation at the current menu for 120 Seconds , controller will automatically return to the main menu and turn off the backlight simultaneously.

5、 User Parameter View and Modification:

In first menu, press the “” and “” to move the cursor to the "USER PARA." item, press the “” to switch to the following menu:

| |
|-----------------|
| P、 T SET |
| SET TIME |
| OPERATION MODE |
| BLOCKING MODE |

| |
|--------------------------|
| CLR LIFE TIME |
| MAX LIFE TIME |
| LANG. LANG. SELECT CH/EN |
| NEW USER PIN: **** |





Move the cursor to the "P、 T SET " item, then press “” to switch to the following menu:

| |
|--------------------------|
| LOAD P: 00.62 MPa |
| UNLOAD P: 00.78MPa |
| FAN START T: 0080℃ |
| FAN STOP T: 0075℃ |

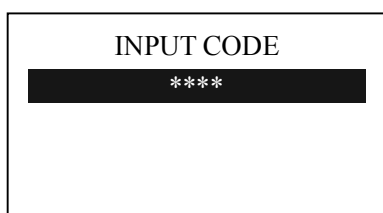
Move the cursor to the “LOAD P” item, then press “” to switch to the following





menu which requires a user password input.

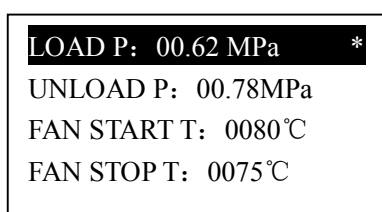

In this menu, the first data bit of password started blinking, press “” or “” to modify the first bit of password. Press the “”, move the cursor to the next data bit, modify the second data of password. In accordance with the above, modify the third and fourth data of password in sequence. Press “” to confirm the input data and the menu will switch to the following menu after verification:



The upper right corner with "*" indicate the system verification of the password

In the menu above, press “”, the first data of loading pressure starts to blink, user can press “” or “” to modify the present data in accordance with the above method. Press “” to move to next data bit and modify to the target data in sequence. When finished, press “” to confirm and save the data. The controller prompt sends out a short voice to tip the completion of parameter set.



6、 User Parameter Sheet and Function

| First menu | Second menu | Preset Data | Function |
|------------|--------------|-------------|--|
| SET P. T. | LOAD P. | 00.60MPa | 1,In AUTO LOADING, compressor will load if pressure is below this set data 2,In STANDBY mode, compressor will start if the pressure is below this set data |
| | UNLOAD P. | 00.80Mpa | 1.Compressor will unload automatically if air pressure is above this set data 2.This data should be set above LOAD P ,also should be set below ULD LIM P |
| | FAN START T | 0080°C | Fan will start if discharge air temperature is above this set data |
| | FAN STOP T | 0070°C | Fan will stop if discharge air temperature is below this set data |
| TIME SET | MASTER DELAY | 0008S | Set the master start time, record time when master is activated, controller will not start overload protection during this time to avoid stopping the master by impulse starting current |
| | FAN DELAY | 0006S | Set the fan start time, record time when fan is activated, controller will not start overload protection during this time to avoid impulse starting current stopping the fan. |
| | STAR DELAY | 0006S | Time from star start to delta start. |

| | | | |
|-----------------------|---------------|-----------------------|--|
| | LOAD DELAY | 0002S | Unloading in this set time after enter delta running |
| | UNLOAD DELAY | 0600S | When unloading continuously, compressor will automatically stop and enter to standby status if over this set time |
| | STOP DELAY | 0010S | For NORMAL STOP operation, compressor will stop after it continuously unloading over this set time |
| | START DELAY | 0100S | Machine can be restarted only over this set time at any case(after NORMAL STOP, STANDBY or FAILURE STOP) |
| OPERATION MODE PRESET | ON/OFF MODE | LOCAL/REMOTE | 1. When set as LOCAL, only the button on the controller can turn on and turn off the machine. 2. When set as REMOTE mode, both the button on the controller and the remote control button can turn on and off the machine; |
| | LOAD MODE | AUTO/MANU | 1.When set as the MANU: only when the pressure is above “unloading pressure”, compressor will unload automatically. For any other case, the Loading/Unloading function can only be executed by pressing “loading/unloading” key. 2.When set as AUTO ,the loading/ unloading function can be executed by the fluctuation of air pressure automatically |
| | COM MODE | PROHIBIT /COMP./BLOCK | 1. When set as PROHIBIT, the communication function is invalid. 2.When set as COMP. ,compressor function as a slave and is able to communicate with computer or DCS 3.When set as BLOCK, compressor can net control |
| | COM ADDRESS | 0001 | Set the communication ADD in block mode or when communicate with monitoring center. This ADD is unique for every controller in net |
| BLOCKING MODE SETTING | BLOCK MODE | MASTER/SLAVE | 1. When service as master in BLOCK. Master controls slave, the COM ADDRESS should be No.1 2.When service as slave in BLOCK, slave is controlled by master |
| | TURN TIME | 0099 Hours | When master pressure is between BLOCK LOAD P and BLOCK UNLOAD P, master determine slave work alternatively over this set time . |
| | BLK NUMER | 0000 | Number of air compressors in block net |
| | BLK MIN | 00.65MPa | In BLOCK, one compressor will start or load when pressure is below this set data |
| | BLK MAX | 00.75MPa | In BLOCK mode, one compressor will stop or unload when pressure is above this set data |
| | BLK DELAY | 0050S | In BLOCK mode, when master sends two commands continuously, second command signal delays for this set data, |
| CLR LIFE TIME | OIL FILTER | 0000H | Record total running time of oil filter, if changing new oil filter, the data should be reset by manual operation. |
| | O/A SEPARATOR | 0000H | Record total running time of O/A separator. If changing new O/A separator, the data should be reset by manual operation |
| | AIR FILTER | 0000H | Record total running time of air filter .If changing new air filter, the data should be reset by manual operation |
| | LUBE | 0000H | Record total running time of lube. If changing lubricate ,the data should be reset by manual operation |
| | GREASE | 0000H | Record total running time of grease. If changing new grease, the data should be reset by manual operation |

| | | | |
|----------------------|---------------|-------|--|
| | BELT | 0000H | Record total running time of belt. If changing new belt, the data should be reset by manual operation |
| MAX LIFE TIME PRESET | OIL FILTER | 9999H | 1, Alarm prompts when total running time of oil filter is above the set data . 2,Set this data to “0” to clear oil filter running time |
| | O/A SEPARATOR | 9999H | 1, Alarm prompts when total running time of O/A separator is above the set data. 2,Set this data to “0” to clear O/A separator running time |
| | AIR FILTER | 9999H | 1, Alarm prompts when total running time of air filter is above the set data. 2,Set this data to “0” to clear air filter running time |
| | LUB | 9999H | 1, Alarm prompts when total running time of lubricate is above the set data. 2, Set this data to “0” to clear lubricate running time. |
| | GREASE | 9999H | 1, Alarm prompts when total running time of grease is above the set data. 2,Set this data to “0” to clear grease running time |
| | BELT | 9999H | 1, Alarm prompts when total running time of belt is above the set data. 2, Set this data to “0” to clear belt running time . |
| LANG.SEL | EN/CH | EN | 1,Set to “EN” , Display in English 2,Set to “CH” , Display in Chinese |
| NEW USER PIN | **** | **** | User could modify the user password by old user password or factory password |

7、 Factory Parameter View and Modification

FACTORY PARAMETER store relatively parameter set by factory. To check FACTORY PARAMETER, you have to verify password first. In the first menu, press “” and “” to FACTORY PARAMETER, press “”to switch to the menu below.

INPUT CODE

Input the correct password to switch to the FACTORY PARAMETER menu as below:

MOTOR CUR: 100.0A
FAN CUR: 010.0A
ALARM T: 0105°C
STOP T: 0110°C

STOP P: 00.90MPa
MAX U.L.: 00.85MPa
RUN TIME: 001234H
LOAD TIME: 001001H

.....

For more factory parameter, please check factory parameter sheet. When modify factory parameter, please refer to customer parameter modification method, supper password is required to set TOTAL RUN TIME,PHASE PROT,POWER FREQ and MAX RUN TIME.

8、 Factory Parameter Sheet and Function

| PARAMETER | Initial Data | Function |
|--------------|----------------------------------|---|
| MOTOR CUR | Maximum motor overload data /1.2 | When the current of motor is more than 1.2 times of the set data , the unit will stop for overload feature. (see table2.1.1) |
| FAN CUR | Maximum fan overload data/1.2 | When the current of fan is more than 1.2 times of the set data , the unit will stop for overload feature. |
| ALARM T. | 105℃ | When discharge air temperature reaches this set data, compressor will alarm |
| STOP T. | 110℃ | When the discharge air temperature reaches this set data, compressor will alarm and stop |
| STOP P. | 1.00MPa | When pressure reaches this set data ,compressor will alarm and stop |
| MAX U.L. | 0.80MPa | This data is the maximum of UNLOADING P. The UNLOADING P in the customer parameter must be set no higher than this data. |
| RUN TIME | 000100Hours | Modify the TOTAL RUN TIME |
| LOAD TIME | 000095Hours | Modify the TOTAL LOAD TIME |
| CLR FAULT | **** | Input the password 8888 and press “set “button to clear all the history failure record. |
| CUR UN.BAL. | 0006 | MAX-MIN \geq SET*MIN/10 ,respond time is 5s If the set data \geq 15, the unbalance protection will be invalid. |
| OPEN PAHSE | 002.0s | If OPEN PHASE protection \geq 20 seconds, OPEN PHASE protection is invalid |
| PROD DATE | ****_**_** | Production date |
| PROD NO | ***** | Product serial No. |
| PHASE PROT.. | ON/OFF | ON: turn on phase sequence protection OFF: turn off phase sequence protection |
| POWER FREQ | 50HZ/60HZ | Set the operation power frequency |
| BLK MODE | ADV/COMPATIBLE | Set as compatible mode, block mode is the same as the other series controller by PLOT When block control with MAM 8*0 controller and set as advanced mode, more block mode function is available |
| HIGH VOL. | 0460V | 1, Controller detects the voltage higher than this set data, the shutdown protection starts and reports HIGH VOL. 2,Set this data to 0000, the HIGH VOL. protection function is invalid |
| LOW VOL. | 0320V | 1,Controller detects the voltage lower than this set data, shutdown protection starts and reports LOW VOL. |

| | | |
|--------------|---------|--|
| | | 2,Set this data to 0000, the LOW VOL. protection function is invalid |
| LOW T PRO- | -0048°C | 1,In stop mode, air compressor is not allowed to start when discharge air temperature is lower than this set data 2,Two minutes after turn on, when the air temperature is below this data, compressor will stop and display T SENSOR FAULT |
| TIME LIM | 0000H | 1,When the compressor is in a stop status and the TOTAL RUN TIME exceeds this TIME LIM set, the controller will stop the compressor and display USER MISTAKE; 2,If this data is set to '0000', TIME LIMIT function is invalid. |
| ALM STOP | 0010H | Controller detects oil filter, O/A separator, air filter, lubricate oil ,grease and belt running with alarming over this ALARM STOP set, compressor will stop and report "ALARM LONG STOP " |
| COM SET PARA | ON/OFF | 1,When set as ON, User can use DCS to set data through MODBUS protocol; 2,When set as OFF, User cannot use DCS to set data through MODBUS protocol 3,User can use DCS to set data only when compressor is at stop status |
| PARA1 | **** | User could modify the factory password by old factory password. |

9、Parameter Calibration

You can set relative data of controller in CALBR PARA. It is not allowed to view and modify without manufacturers authorization, so please verify the password before view and modification. The modification of CALBR PARA is similar with CUSTOMER PARA. Main function is shown as below.

| PARAMETER | | Initial Data | Function |
|--------------------------------|------------|--------------|--|
| M O T O R A | TARGET CUR | 0000 | 1,When calibrate the current of motor A, revise standard current data, controller calibrate the current by figuring the current coefficient and save the data automatically 2,Standard current data will return to zero after calibration |
| | COEF | 1.000 | When calibrate the current, revise coefficient. Current data in display=sample data*coefficient |
| | CUR | ***.*A | This data is qret |
| M O T O R B | TARGET CUR | 0000 | 1,When calibrate the current of motor B, revise standard current data, controller calibrate the current by figuring the current coefficient and save the data automatically 2,Standard current data will return to zero after calibration |
| | COEF | 1.000 | When calibrate the current, revise coefficient. Current data in display=sample data*coefficient |
| | CUR | ***.*A | this data is qret |

| | | | |
|-----------------------|------------|--------|--|
| M O T O R | TARGET CUR | 0000 | 1,When calibrate the current of motor C, revise standard current data, controller calibrate the current by figuring the current coefficient and save the data automatically 2,Standard current data will return to zero after calibration |
| | COEF | 1.000 | When calibrate the current, revise coefficient. Current data in display=sample data*coefficient |
| | CUR | ***.*A | this data is qret |
| F A N A | TARGET CUR | 0000 | 1,When calibrate the current of fan A, revise standard current data, controller calibrate the current by figuring the current coefficient and save the data automatically 2,Standard current data will return to zero after calibration |
| | COEF | 1.000 | When calibrate the current, revise coefficient. Current data in display=sample data*coefficient |
| | CUR | ***.*A | this data is qret |
| F A N B | TARGET CUR | 0000 | 1,When calibrate the current of fan B ,revise standard current data, controller calibrate the current by figuring the current coefficient and save the data automatically 2,Standard current data will return to zero after calibration |
| | COEF | 1.000 | When calibrate the current, revise coefficient. Current data in display=sample data*coefficient |
| | CUR | ***.*A | this data is qret |
| F A N C | TARGET CUR | 0000 | 1,When calibrate the current of fan C ,revise standard current data, controller calibrate the current by figuring the current coefficient and save the data automatically 2,Standard current data will return to zero after calibration |
| | COEF | 1.000 | When calibrate the current, revise coefficient. Current data in display=sample data*coefficient |
| | CUR | ***.*A | this data is qret |

10、 Operating Authorization and Password

Controller provides multiple passwords and access management. According to different levels of passwords, controller provides different levels of operating authorization, details as following:

- 1、 User operation password: fixed: _____
Permissions: allows to modify the LOADING P, UNLOADING P, FAN START T, FAN START T, ON/OFF MODE, LOAD MODE, COM MODE, COM ADD and BLOCKING MODE.
- 2、 New user password: factory set: _____
Permissions: Allows to modify all CUSTOMER PRAMETER.
- 3、 Manufacturer sales password: factory set: _____
Permissions: Allows users to modify all CUSTOMER PRAMETER, the NEW USER PIN, some MANUFACTURER PARAMETER, MANUFACTORY SALES PASSWORD.

- 4、Manufacturer operation Password: fixed:_____

Permissions: Allows users to modify all CUSTOMER PRAMETER, the NEW USER PIN, some MANUFACTURER PARAMETER, MANUFACTORY SALES PASSWORD.
- 5、Calibrate Password: fixed:_____

Permissions: Allows users to calibrate currents in CALBR PARAMETER.
- 6、Super Password: fixed:_____

Permissions: Allows users to modify TOTAL RUN TIME,PHASE SEQUENCE PROTECTION, OPWER FREQUENCY ,TIME LIMIT after user enter factory parameter and verify supper password.

2、 Controller Function and Technical Parameter

- 1、 Digital input: 3 points of digital input ;5 points of digital relay output ;
- 2、 Analog input: 1 point of Pt100 temperature input ; 1 point of 4~20mA pressure signal input; two groups of three phases current inputs(CT provided);
- 3、 Input voltage of phases:380V/220V;
- 4、 Compressor protection of high operation voltage and low operation voltage
- 5、 Controller working power supply: AC16-28V、 50/60HZ、 0.3A、 5VA (recommend 10VA)
- 6、 Measurement :
 - ①、 Discharge air temperature:-50~150℃; Accuracy: ±1℃.
 - ②、 Operation time: 0~999999 hours.
 - ③、 Current:0~999.9A.
 - ④、 Pressure: 0~1.60MPa. Accuracy: ±0.01Mpa.
- 7、 Phase sequence protection: When compressor is at stop mode and detects wrong phase sequence, respond time ≤ 1s (optional);
- 8、 Open phase protection: When compressor is at stop mode and detects open phase ,respond time ≤ 1s
- 9、 Motor protection : This controller has basic protection function for main motor and overload protection for fan.
 - ①、 Open phase protection: When any phase opens, the respond time equals to set time, when phase open time is set above 20s,open phase protection is invalid;
 - ②、 Unbalance protection: when $MAX-MIN \geq SET*MIN/10$,respond time is 5s;
 - ③、 Protection features of overload (time unit: second), please see following table (table 2.1.1), multiple $= I_{actual} / I_{set}$,motor operates with delay time according to overload multiples and operation time shown in following table (table 2.1.1) when motor working current is higher or equal to the set current from 1.2 times and 3.0 times .

| I_{actual}/I_{set} | ≥ 1.2 | ≥ 1.3 | ≥ 1.5 | ≥ 1.6 | ≥ 2.0 | ≥ 3.0 |
|----------------------|------------|------------|------------|------------|------------|------------|
| Time parameter | | | | | | |
| Response time (S) | 60 | 48 | 24 | 8 | 5 | 1 |

Table 2.1.1 curve table for protection of motor

- 10、 Temperature protection: when actual temperature measured is higher than temperature set; response time \leq 2s;
- 11、 Contact capacity of output relay: 250V,5A; Contact endurance :500000 times
- 12、 Current error is less than 1.0%.
- 13、 RS485 communication function
 - 1,Block mode control
 - 2, Communicate with-external devices as slave through MODBUS RTU, baud rate 9600BPS,1start bit,8 data bits,1 stop bit and even parity
- 14. Remote control compressor: When set as remote control mode, user can remotely control the compressor.

3、 Model and Specification

1、 Model Description

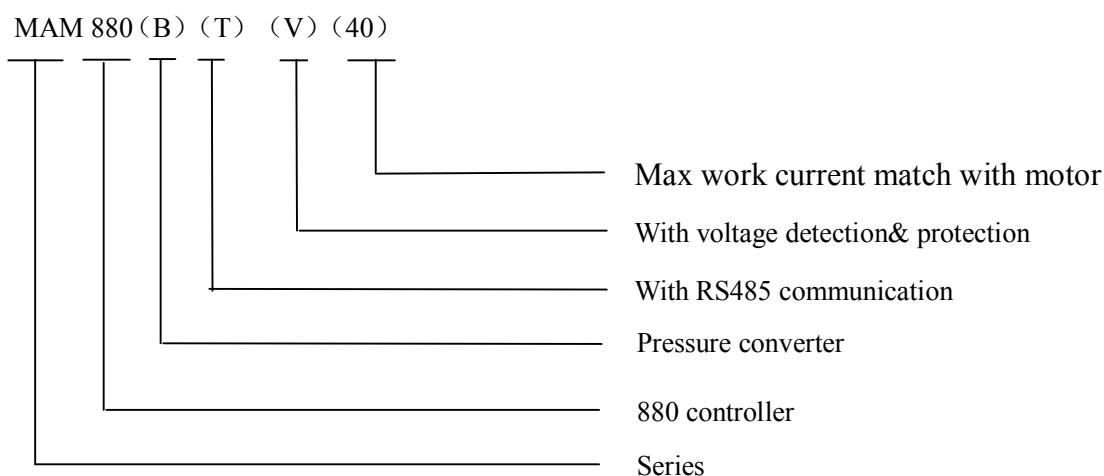

2、 Power consumption Table for Corresponding Motor

| Parameter Specification | Current range (A) | Corresponding main motor power (KW) | Remark | Description |
|----------------------------|----------------------|---|---------|---|
| MAM880 (20) | 8~20 | Below 11 | | Fan has three levels of current, such as 0.2-2.5A, 1-5A and 4-10A, determined by current of motor |
| MAM880 (40) | 16~40 | 11-18.5 | | |
| MAM880 (100) | 100 | 22-45 | | |
| MAM880 (200) | 200 | 55-90 | | |
| MAM880 (400) | 400 | 110 | | |
| MAM880 (600/5) | 600/5 | 200-250 | With CT | |

Table 3.2.1 Power consumption specification sheet for corresponding motor

4、 Installation

1、 Mechanical Installation

①、 Current transformer installation

The CT shall be installed at a place where the current of motor cable can be measured, thus controller can be set according to instructions on motor nameplate, the detailed dimensions is shown as below:

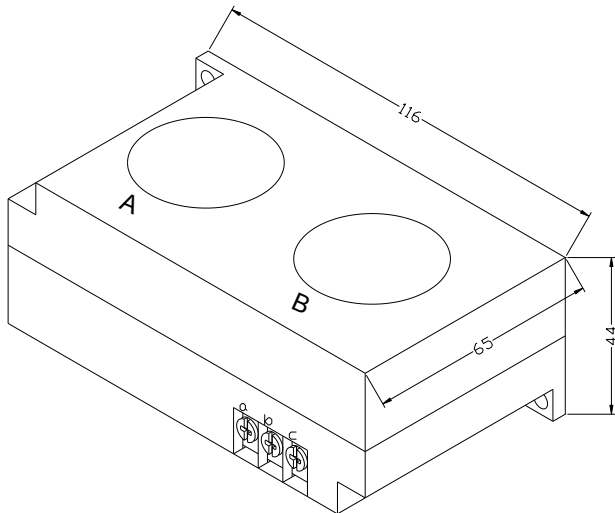

Figure 4.1.1. Structure dimensions of CT1 ($\phi 36$ through hole)

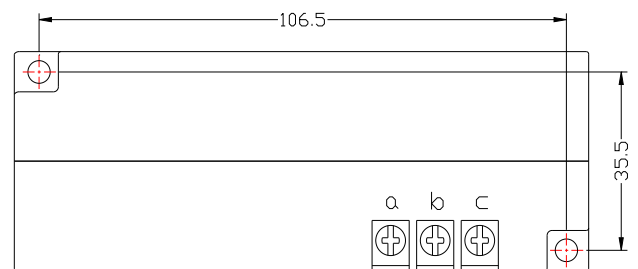

Figure 4.1.2. Installation dimensions of CT1

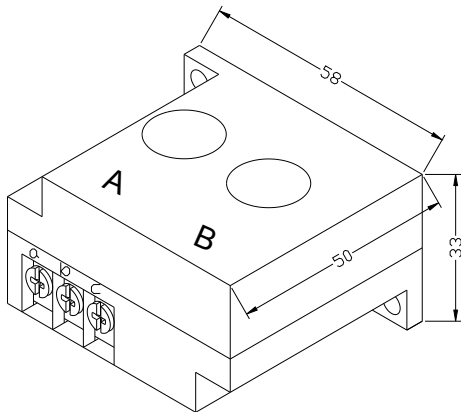

Figure 4.1.3. Structure dimensions of CT2 ($\phi 10$ through hole)

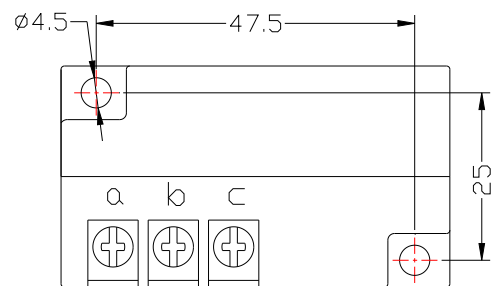

Figure 4.1.4. Installation dimensions of CT2

②、Controller installation

A certain room should be left around controller for wiring. The specific dimension is shown as below:

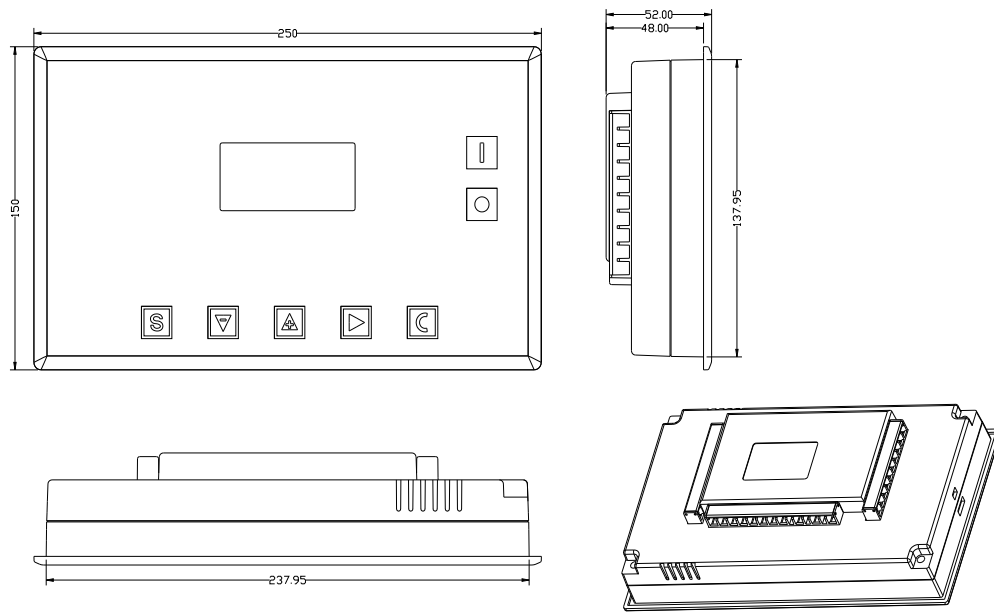

Figure 4.1.5 Controller structure dimension

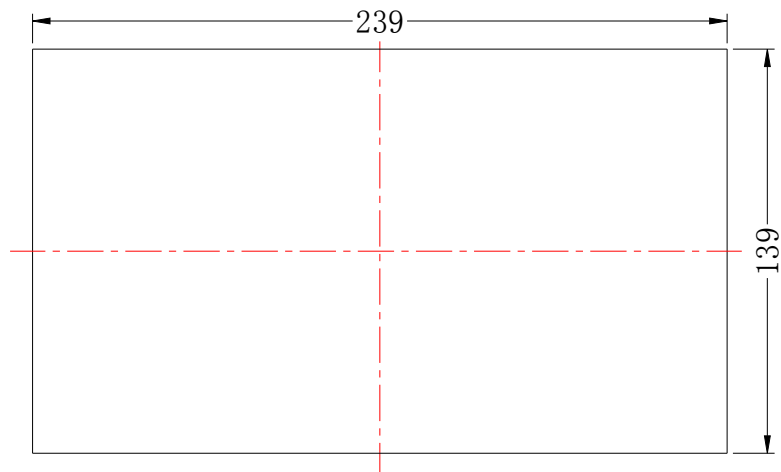

Figure 4.1.6 Hole size

2、Electrical Wiring Installation

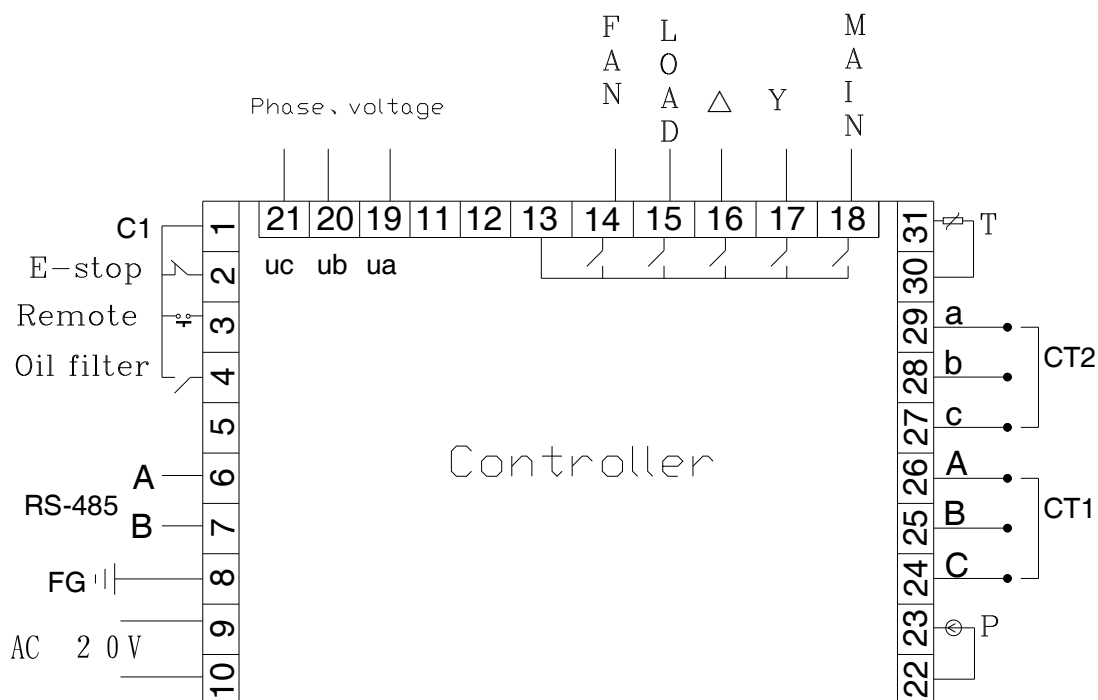

Figure 4.2.1 Terminal arrangement diagram

Cable connection of controller:

| | | | | | |
|-----------|---|-----------|---|-----------|---|
| 1 | Common terminal for digital input | 2 | Input terminal for emergency stop signal | 3 | Input terminal for remote control signal (on/off) |
| 4 | Input terminal used to detect oil filter | 5 | N/A | 6 | RS485+ |
| 7 | RS485- | 8 | Terminal for ground connection | 9 | Terminal for the AC20V power source |
| 10 | Terminal for the AC20V power source | 11 | N/A | 12 | N/A |
| 13 | Common terminal for digital output | 14 | Terminal to control fan | 15 | Terminal to control load valve |
| 16 | Terminal to control delta contactor | 17 | Terminal to control star contactor | 18 | Terminal to control main contactor |
| 19 | Input terminal to detect the phase sequence and voltage | 20 | Input terminal to detect the phase sequence and voltage | 21 | Input terminal to detect the phase sequence and voltage |
| 22 | Power terminal for pressure sensor | 23 | Input terminal to receive pressure sensor signal | 24 | Terminal for motor CT1 input |
| 25 | Terminal for motor CT1 input | 26 | Terminal for motor CT1 input | 27 | Terminal for fan CT2 input |
| 28 | Terminal for fan CT2 input | 29 | Terminals for fan CT2 input | 30 | Terminal for AIR T |
| 31 | Terminal for AIR T | | | | |

5、 Control Process

1、 Single Machine

1, Working principle(On/off mode: Local; Load mode: Auto)

①. Press “”to start: (Y- Δ start)

The air compressor can not be started by pressing “”until 5 seconds self checking finished. The start process of compressor is as followed: 18 terminal closed, KM2 is energized;17 terminal closed ,KM3 is energized \rightarrow Y start \rightarrow STAR DELAY time starts record; when Y- Δ transfer time over,17 terminal open ,KM3 is de-energized and 16 terminal closed,KM1 is energized \rightarrow motor operates in Δ . (KM1 and KM3 are interlocked)

②. Automatic operation control:

A, When motor enter delta status, LOAD DELAY starts, controller will load automatically after LOAD DELAY.

B, If air pressure is detected higher than UNLOADING P set,15 terminal opens, loading valve is de-energized, and air compressor starts unloading, and also starts EMPTY LONG STOP time record ,if unloading time exceed EMPTY LONG STOP set, compressor will enter STANDBY mode; if compressor loading again within “EMPTY TIME” set(when pressure is below LOADING P or receiving load command),compressor will reset “EMPTY LONG STOP”.

C, In STANDBY mode, controller start automatically if pressure detected is below LOADING P

③. Manual loading/unloading operation under automatic status

A: When air pressure is between LOADING P and UNLOADING P, press “loading/ unloading” to switch the current status of controller.

B, When air pressure is above the UNLOADING P, controller unloads automatically, the loading/unloading button is invalid

C, When air pressure is below the UNLOADING P, controller loads automatically, the loading/unloading button is invalid

④. Normal stop:

Press “” , the loading magnetic valve will be de-energized, after a while of delay (stop delay), all output relay stop working.

⑤.The frequent starting control

Air compressor can not start again immediately after NORMAL STOP ,EMPTY LONG STOP or FAILURE STOP. It can start again after START DELAY.

2, Remote Automatic Control (Control Mode: Remote; Load Mode: Auto)

In this mode, compressor can be turned on or off by remote control.

3, Local Control (Control Mode: local, Load Mode: Manual)

A, Control of start and stop are same as automatic control, but device is in status of unloading after finish starting process.

B, In unload status, press “” to load. When air pressure is higher than UNLOADING P set, the device will unload automatically.

C, If not press “loading/ unloading”, the device will run unload until EMPTY LONG STOP.

D, In load status, press “” to unload.

2、 Net Work

- ①. Controller works as slave when communication mode is set as "computer", and communicates with monitoring center through MODBUS.
- ②. Controller and other controller can block work when communication mode is set "block" but the master only can service as 1# compressor.

3、 Fan Operation

When discharge air temperature is higher than FAN START T, fan operates; when discharge air temperature is lower than FAN STOP T, fan stops.

6、 Alarm Function

1、 Air Filter Alarm

The monitor displays AIR LIFE END when the running time of the air filter exhausts.

2、 Oil Filter Alarm

- ①. Oil filter block check.

The monitor displays OIL BLOCK by checking pressure differential switch-operating state.

- ②. Oil filter alarm

The text displays OIL LIFE END when running time of the oil filter exhausts.

3、 O/A separator Alarm

The text displays "O/A LIFE END" when running time of the O/A separator exhausts.

4、 Lubricating Oil Alarm

The text displays LUBE LIFE END when running time of the lubricating exhausts.

5、 Grease Alarm

The text displays GREASE LIFE END when running time of the grease exhausts.

6、 Belt Alarm

The text displays BELT LIFE END when running time of the belt exhausts.

7、 High Discharge Air Temperature Alarm

The text display HIGH TEMPERATURE when controller detects the discharge air temperature higher than ALARM T set data in MANUFACTORY PARA.

7、 Controller Protection

1、 Motor Protection

MAM-880 air compressor controller provides overload, open phase, current unbalance, high voltage, low voltage protection for motor and overload protection for fan

| Electronic failure | Failure Display | Reason |
|--------------------|-------------------------------|--|
| Overload | Display “MOTOR/FAN OVER LOAD” | Overload, bearing wear and other mechanical failure |
| Open phase | Display “MOTOR OPEN PHASE” | Power supply, contactor and open phase of motor |
| Unbalance | Display “MOTOR UNBLANCE” | Poor contact of contactor, inside open-loop of motor |
| High voltage | Display“ HIGH VOLTAGE” | High supply voltage |
| Low voltage | Display “LOW VOLTAGE” | Low supply voltage |

2、 Protection of Air Temperature High

When discharge air temperature is above the high limit of set temperature, the controller will send out the alarm to shut down the machine and This fault displays HIGHT T.

3、 Protection of Air Compressor Non-reversing

When compressor stops and three-phases sequence is not in order, THIS FAULT displays PHASE REVERSAL, and the controller cannot start the motor. Change the position of any arbitrary two-phase power lines and check the rotation of motor.

4、 Protection of High Pressure

When the discharge air pressure is above the MAX LIM P, the controller will send out the alarm to shut down the machine and THIS FAULT displays HIGH P.

5、 Protection of Sensor Failure

When pressure sensor or temperature sensor is disconnected, the controller will send out the alarm to shut down the machine and THIS FAULT displays **SENSOR FAULT.

6、 Low Temperature Protection

When discharge air temperature is below LOW T PRO in manufacturing parameter, THIS FAULT displays P SENSOR FAULT two minutes after compressor turns on, the controller will send out the alarm to shut down the machine .

8、 Troubleshooting

1、 This Fault Review

Failure stop caused by the external parts of controllers may be removed by checking THIS FAULT or HISTORY FAULT , method is shown as below:

Press “” to move the cursor to “RUN PARAMETER” menu, then press “”, the secondary menu would be prompted out:

MOTORS /FAN CURRENT
TOTAL RUN TIME
THIS RUN TIME
CLR LIFE TIME

HISTORY FAULT
PROD DATE NO.
THIS FAULT
COM STATUS.

Move cursor to THIS FAULT press “” to switch to the following menu:

STOP:T SENSOR FAULT
0170℃

User can reset the error according to the following information

2、 Common Failures and Causes

| Failure | Reason | Solution |
|----------------------------------|---|---|
| AIR T High | Bad vent condition, Oil shortage etc. | Check the vent condition and lubricant amount etc. |
| Temperature Sensor Failure | Cable off or PT100 failure | Check the wiring and PT100 |
| AIR P HIGH | Pressure too high or the pressure sensor failure | Check the pressure and the pressure converter |
| Pressure Sensor Failure | Cable off, Sensor failure or the cable connect reversed | Check the wiring and pressure converter |
| Open Phase | Power open phase or the contactor terminal failure | Check the power and contactors |
| Overload | Voltage too low, tubes block, bearing wear off or other mechanical failure or wrong set data etc. | Check the set data, voltage, bearings, tubes and other mechanical system. |
| Unbalance | Power unbalance, contactor failure or the internal open loop of the motor | Check the power, contactor and the motor |
| Wrong Phase Sequence | Reversed phase sequence or open phase | Check the wiring |
| Overload during start | Master start time set to less than the star delta delay time | Reset the master start time to be longer than star delta delay + 2 seconds |
| Main Contactor shakes frequently | The emergency button loose, controller reset by interference | Check the wiring; if the coil of contactor connect with surge absorber or not |

9, Block mode control and net work

1. Block mode control

① Block control explanation

MAM880 controller can block operate with MAM series compressor (with communication function). 16 pcs compressors are allowed in the net at most. The cable connection for block mode control is as below...

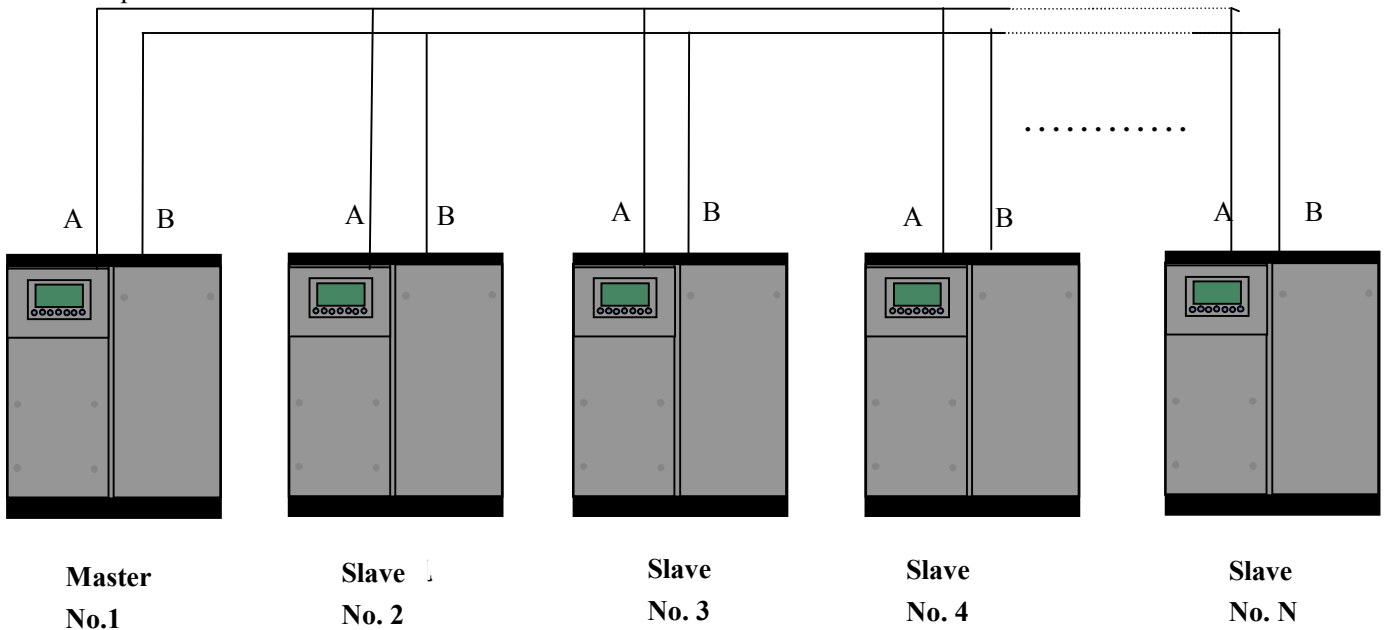



Picture 9.1.1

Compressor with net communication address 0001 is master, others are slave. Any one MAM series compressor can be set as master or slave.

② Block mode setting

1. Set as master:

In main menu, press “” to enter select menu and choose USER PARAMETER, press “” and switch to the menu below:

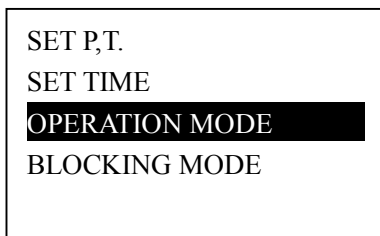

Move the cursor to OPERATION MODE, press “” to switch to the menu below.

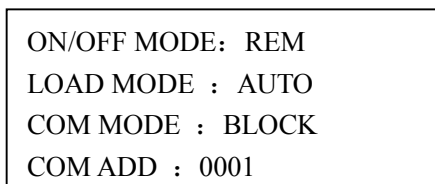

Set COM MODE as BLOCK,COM ADD as “0001”,return to the previous menu ,move the cursor to BLOCKING MODE press “” to switch to the menu below

BLK STATE: MASTER
 ALTER TIME: 0002H
 BLK NUMER.: 0004
 BLK MIN: 00.62MPa

BLK MAX: 00.78MPa
 BLK DELAY: 0020s

According to user requirement, set BLK STATE as MASTER, set ALTER TIME,BLK NUMER,BLK MIN,BLK MAX,BLK DELAY according to user’s need .After setting ,controller needs to be powered off and restarts to the setting.

2.Set as slave:

When MAM controller serves as slave ,it is only necessary to set COM MODE as BLOCK mode, set COM ADD from2-16 with sequence according to the quantity of compressors, .BLK STATE set as SLAVE.



③、Start ,stop block control:

Make sure block cables connect correctly and the parameter of compressors in net set correctly. Activate master, master controls the compressors in net automatically according to the air pressure detected . Block control stops at the same time when manually stop the master so master will no longer send command to compressor in net .

Discharge air TEM: 78°C 
 Air pressure: 0.53MPa
 NORMAL STOP 0s
 C16 remote control

 Blinking icon indicate master has activate block mode function

④、Block communication receiving and sending message:

The message received and sent by RS485 can be displayed by the corresponding indication screen which is convenient for customer to make sure if they have received and feedback data in BLOCK mode or COM MODE. The method to switch to communication menu is as below: press “” in main menu and enter main menu and select run parameter and move down the cursor to communication menu, press “” and switch to the COM MODE menu as below

RX: —
 TX: —

When controller receives data, RX:“— ”and“*”display alternately, When sends data, TX:“— ”and“*”display alternately. When controller is in block control or communicates with monitoring center ,user can confirm the establishment of communication through this menu.

2.Net Work

MAM880 controller supports MODBUS RTU protocol and can serve as slave when connect with other equipment and supports 03、 06、 16 MODBUS command. Communication baud rate:9600BPS, 1 start bit, 8 data bits, 1 stop bits and even parity. For MODBUS register address, please see MODBUS communication manual.

10.Schematic Diagram

